

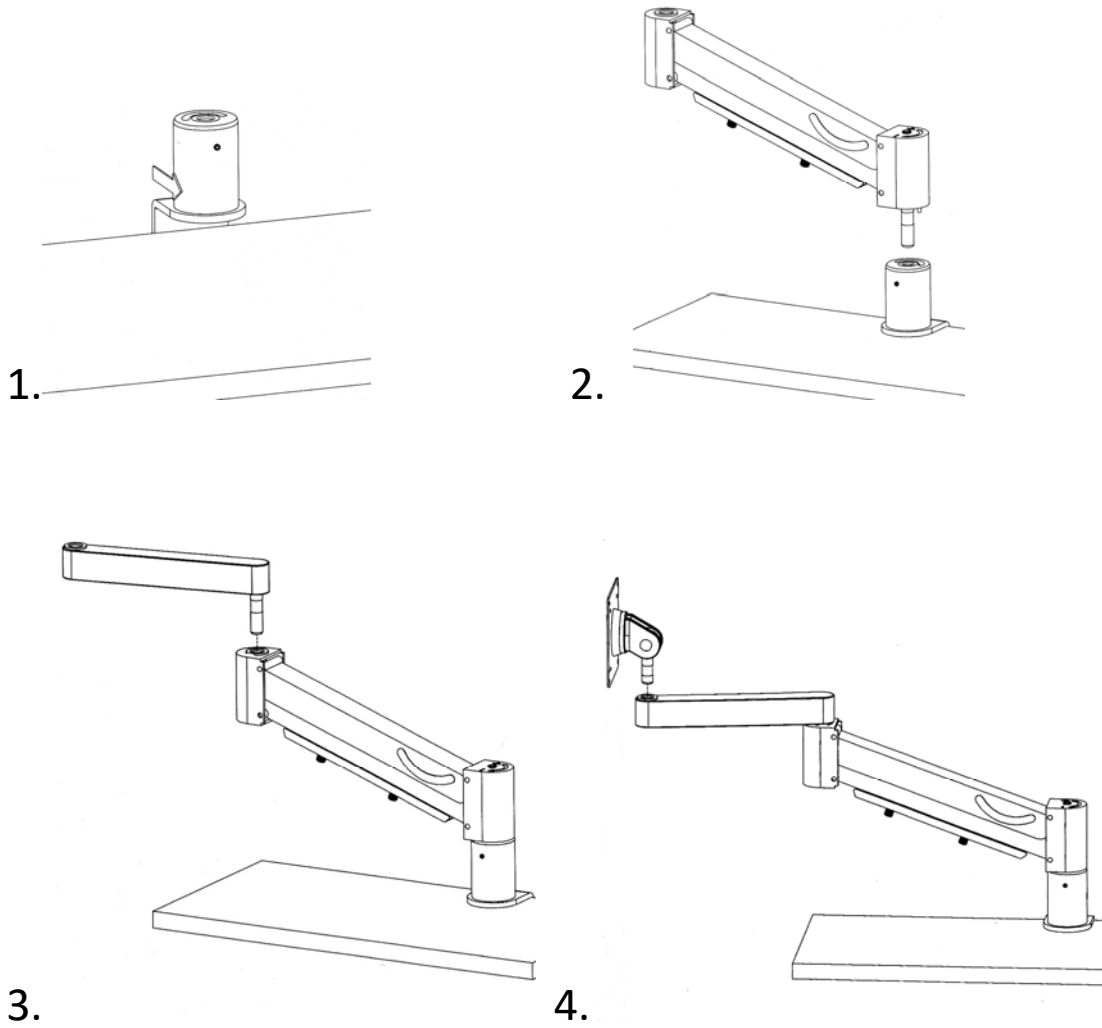

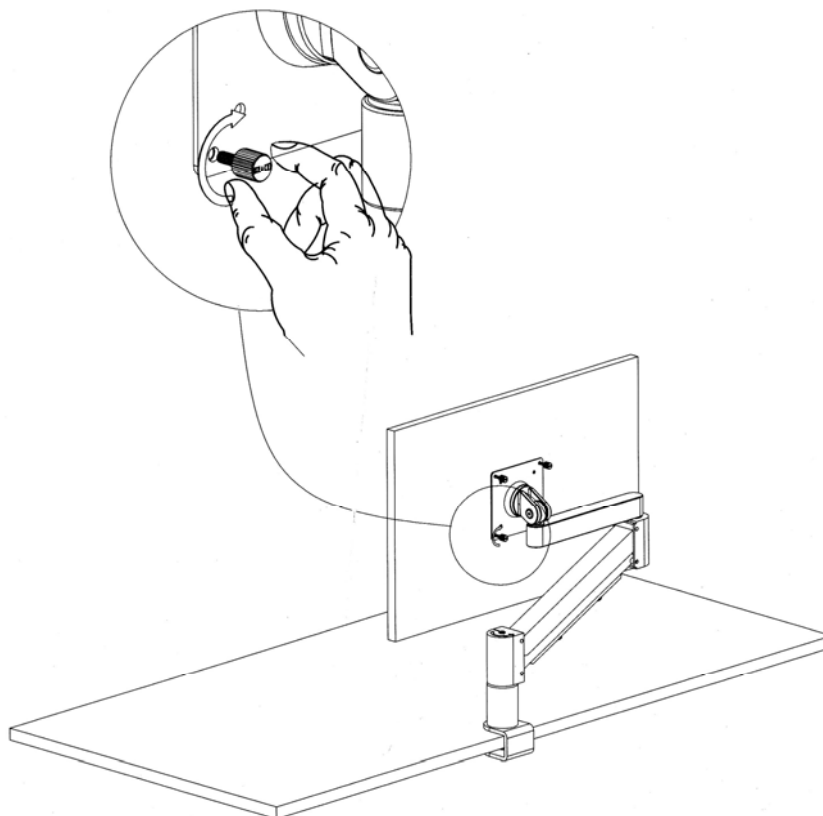



Monteringsanvisning SPACE



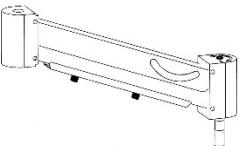

5.

Ingående delar

	<p>ArtNr. 7-960001-1 Monitorfäste VESA 75 / 100mm</p>
	<p>ArtNr. 7-950004-1 Gasarm 3-10 Kg Alternativt ArtNr. 7-950005-1 Gasarm 6-16 Kg</p>
	<p>ArtNr. 7-980100-1 Bordsklämma</p>
	<p>ArtNr. 7-970100-1 Arm 220mm</p>
	<p>ArtNr. 7-10201299-1 Skruvset (4)</p>